

User Manual

Swing Barrier Turnstile

Applicable Model(s): SBT2000S (2023)

Date: January 2025

Doc Version: 1.1

English

About the Manual

This manual introduces the operations of **SBT2000S (2023) Swing Barrier Turnstile..**

All figures displayed are for illustration purposes only. Figures in this manual may not be exactly consistent with the actual products.

Features and parameters with ★ are not available in all devices.

Table of Contents

1	OVERVIEW	5
1.1	FEATURES	5
1.2	APPEARANCE AND SYSTEM COMPONENTS	6
1.2.1	APPEARANCE	6
1.2.2	SYSTEM COMPONENTS	7
1.3	TECHNICAL SPECIFICATIONS	8
1.4	MECHANICAL SYSTEM	9
1.5	ELECTRONIC CONTROL SYSTEM	9
1.6	STATUS OF TRAFFIC INDICATOR	9
1.7	WORKING PRINCIPLE	10
2	FUNCTION INTRODUCTION	11
2.1	CARD VERIFICATION	11
2.2	FACE VERIFICATION★	12
3	CONTROL SYSTEM INTRODUCTION	14
3.1	WIRING DIAGRAM	14
3.2	ACCESS CONTROL BOARD★	15
3.3	TURNSTILE CONTROL BOARD	16
3.4	MENU OF SPEED GATE	18
3.5	ERROR CODE FOR TURNSTILE	26
4	TROUBLESHOOTING	27
5	MAINTENANCE	28
5.1	CHASSIS MAINTENANCE	28
5.2	MOVEMENT MAINTENANCE	28
5.3	POWER SUPPLY MAINTENANCE	28
6	PACKING LIST	29

Revision History

Revision	Date	Author	Reviewer	Description
V1.0	02/29/2024	Yang Kaijin		Original Document
V1.1	01/23/2025	Stella		Modify the parameters

1 Overview

The SBT2000S (2023) swing barrier turnstile is designed for smooth and silent operation, drawing very little power. It is made of SPCC, it is highly durable. These barriers are normally held in a locked position, denying access to the secured side. When SBT2000S (2023) reader positively recognizes a user's valid access card, its barriers swing automatically, allowing users passage to the secured side. During emergencies, the barriers automatically swing, thereby ensuring users fast unencumbered exit to safety. In an event of power outage, users can easily push through the barrier to exit to safety. The SBT2000S (2023) swing barrier turnstile provides both security and convenient space in a durable and elegant compact design.

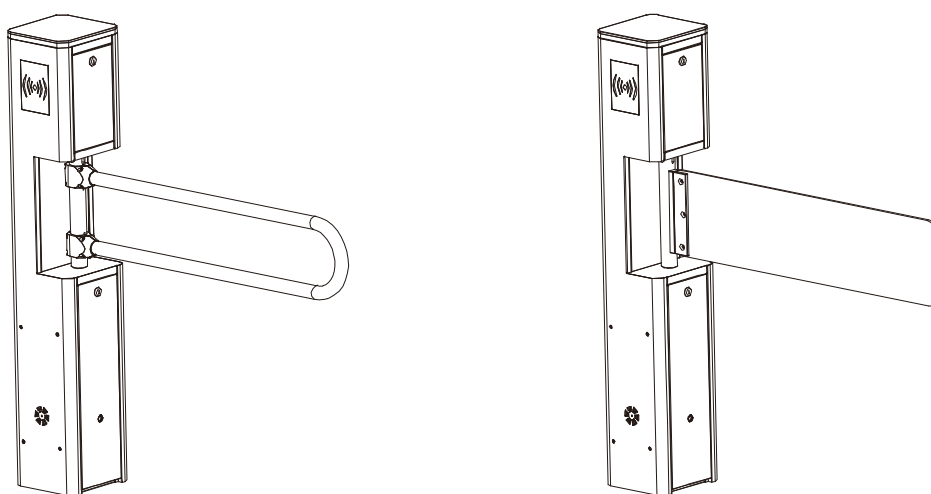

1.1 Features

- **Long Service Life:** The gate can open and close over 5 million times with regular maintenance.
- **High-End Moter:** The motor is driven by a high-end DC brushless motor with a planetary metal gear reducer for high speed, precision, silence and reliable operation.
- **Multi Alarm Functionality:** Alerts break-in, and gate opening/closing delays.
- **Emergency Mode:** Automatically open door during fire alarm or power off.
- **Pass Status Indicator:** Provides visual indication of pass status.
- **Latest Driver Technology:** Adopt the latest driver with RS485 communication protocol, multiple mode switching, with over-current, over-voltage and over-temperature protection.
- **Anti-Pinch Function:** Halts gate closure upon detecting an anti-pinch signal during the closing process.
- **Automatic Reset:** Cancels pass authority automatically if the pedestrian fails to pass within the specified time after a valid card is read.

- **Access Control Capability:** External port allows connection to various biometric devices for access control.

1.2 Appearance and System Components

1.2.1 Appearance

The figure below illustrates the appearance and dimensions of the SBT2000S (2023):

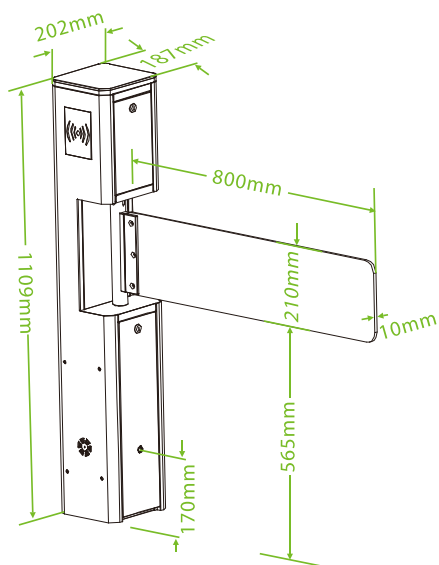

Glass barrier/acrylic (optional)

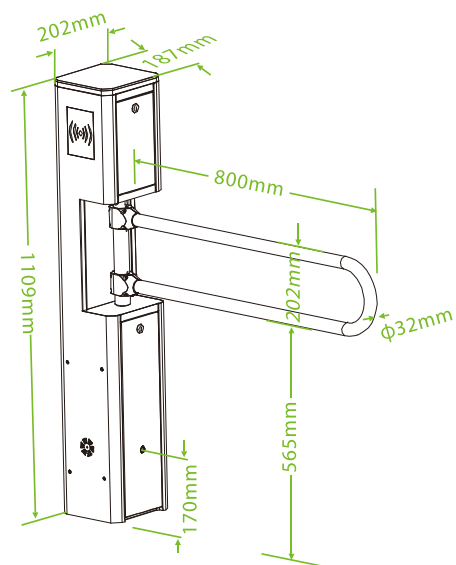

Stainless steel bar

1.2.2 System Components

The following figure displays the system components of the SBT2000S (2023):

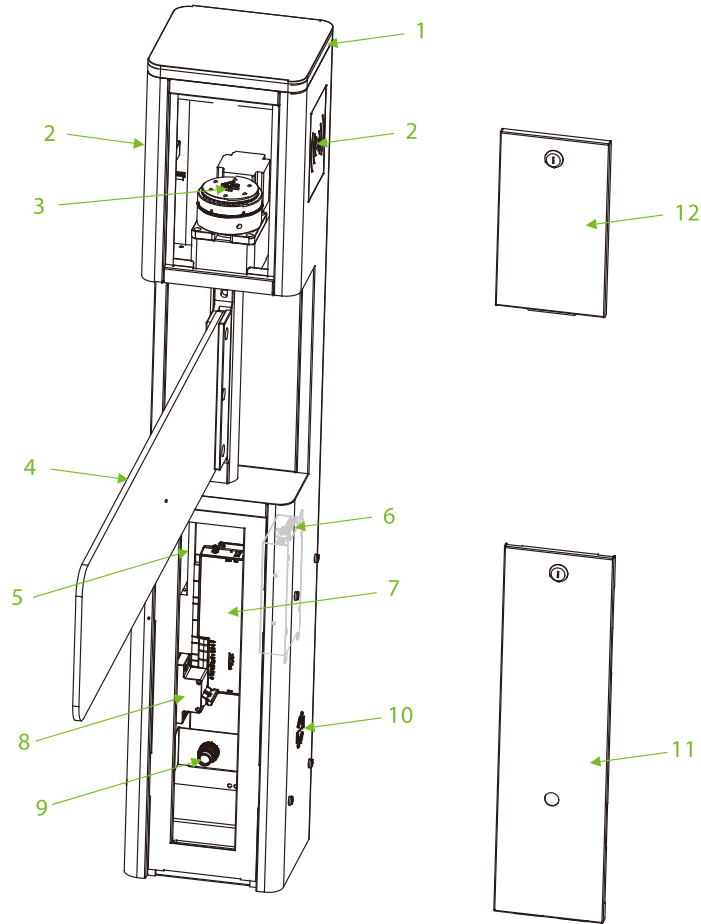

1. Traffic Indicator	2. Card Verification Area
3. Motor Driver Kit	4. Swing Arm
5. Power Supply	6. Turnstile Control Board
7. Access Controller Board★	8. Air Switch
9. Infrared Sensor	10. Speaker
11. Access Door	12. Access Door

1.3 Technical Specifications

Feature	Specification
Communication	TCP/IP, RS485
Input Voltage	AC110V/240V, 50/60Hz
Input Control Signal	Dry Contact
Output Voltage	DC 24V
Time of Gate Opening/Closing	0.8 to 5 Sec
Operating Humidity	20% to 93% (Non-condensing)
Operating Temperature	-15°C to 60°C
Flow Rate	Normally Close: Maximum 30/minute
Drive Unit	Brushless Motor
Infrared Sensor	1 pair
LED	Support
Working Environment	Indoor and outdoor
Dimension (mm) (L*W*H)	202 x 187 x 1109
Weight	25kg (±5kg)
Noise	<10dB
MCBF	5 million
Infrared Detection Distance	<1000mm
Certifications	CE, FCC

1.4 Mechanical System

The turnstile's mechanical system consists of the chassis and core component. The chassis serves as a carrier and holds the Traffic Indicator, Reader, Infrared Sensor, and Door lock. The core components are the Motor, Frame, and Swing Arm.

1.5 Electronic Control System

The electronic control system of a swing barrier turnstile mainly consists of the Card Reader, Turnstile Control Board, Access Controller, Infrared Sensor, Traffic Indicator, and Alarm.

Card Reader: The reader reads the data on the card and transmits it to the Access Controller.

Turnstile Control Board: The turnstile control board serves as the control center of the system, receiving signals from the access controller and photoelectric switch. It makes logical judgments and processes these signals, then subsequently sends executive commands to the traffic indicator, motor, and alarm.

Access Controller: This component enhances convenience for authorized personnel by facilitating entry while simultaneously restricting access for unauthorized individuals.

Traffic Indicator: It displays the current passage status of the lane and guides pedestrians to pass through the lane in a safe and orderly manner.

Alarm: This system issues an alarm alert when it detects unauthorized entry or illegal access by pedestrians.

1.6 Status of Traffic Indicator

The swing barrier turnstile is in a working state after power-on self-test. The traffic indicators provide pedestrians with the appropriate passage indications.

Standby:

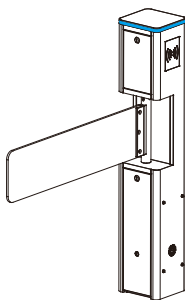

Pass-through (In/Out):

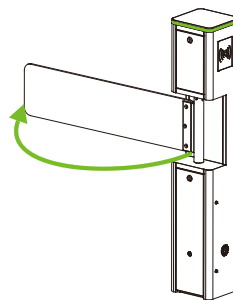

Alarm:

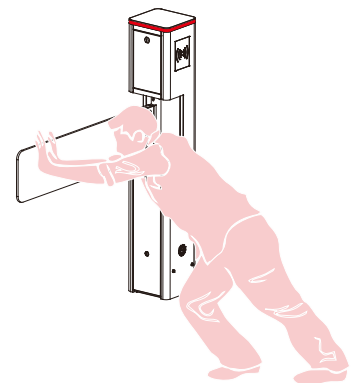

1.7 Working Principle

1. When connected to power, the swing barrier turnstile undergoes a Power-On Self-Test. If no issues are detected during this process, the turnstile will operate normally. If a failure is detected, the system will display relevant error messages on the digital tube, allowing the user to quickly identify and resolve the problem.

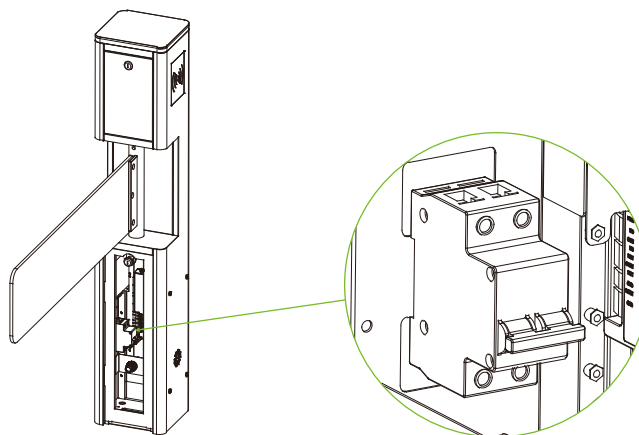

2. When a valid card/Face★ is detected, the buzzer will give a positive audible prompt to the pedestrian, indicating that successfully verified. Then, the card reader/Camera★ sends signals to the Access Controller to request permission to pass through the passage. The Access Controller will send the signal to the Turnstile Control Board.
3. After presenting the valid card/Face★, the turnstile control board receives the signals from the access controller and the infrared sensor. It processes these signals, and then sends out valid control signals to the traffic indicator and the motor. The traffic indicator turns green, and at this time, if the system is in the normally closed mode, the motor operates, and the gate opens.
4. After the passenger passes through the lane in accordance with the opening direction of the swing arm, the Infrared Sensor will continuously monitor the pedestrian's movement throughout the passage. It will continue to send signals to the Turnstile Control Board until the pedestrian completes the passage.
5. If a pedestrian enters the passage without successfully verifying their identification or with an invalid card/Face★, the system will not grant passage. Only when a valid card/Face★ is successfully confirmed will the pedestrian be allowed to pass through the passage.

Note: Make sure the ground wire of the system is securely connected to avoid personal injuries or other accidents.

2 Function Introduction

2.1 Card Verification

In card verification mode, the device compares the card number in the card induction area with all the card number data registered in the device and sends it to the access controller. When the user brings the card close to the card reading area, the device enters the card verification mode. When the validation is successful, the traffic indicator of the device turns green, the arm can be pushed, and passage is allowed. In case of validation failure, the traffic indicator turns red, preventing the arm from being pushed, and at the same time, an alarm sounds, and passage is prohibited.

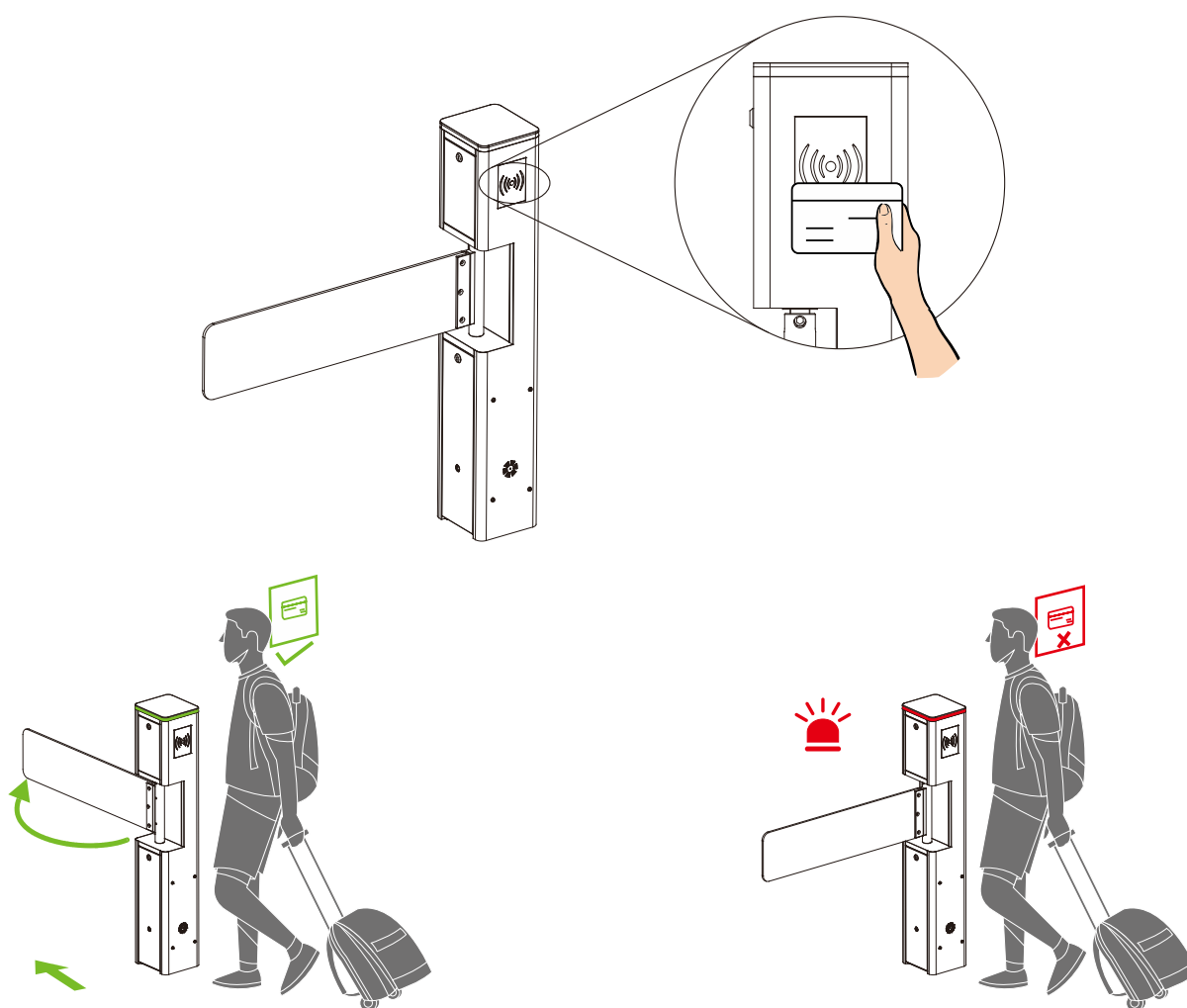

2.2 Face Verification★

In facial verification mode, the device compares the facial template captured by the camera with all the facial data registered in the device and sends it to the access controller. When the verification is successful, the traffic indicator of the device turns green, the arm can be pushed, allowing passage. In case of verification failure, the traffic indicator turns red, preventing the arm from being pushed. and an alarm sounds, prohibiting passage.

During the verification process, please try to center your face on the screen. When registering facial information, please make sure your face is facing the camera and remain still.

Recommended Standing Posture and Facial Expression:



Note: Maintain a natural facial expression and standing posture during both enrollment and verification processes.

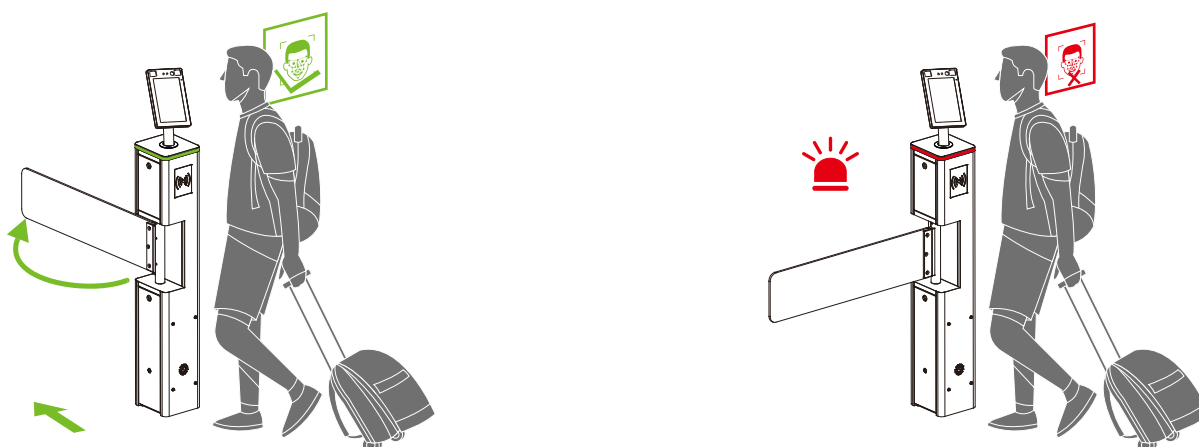

Installation on the swing barrier turnstile:

- a) Before installation, insert the wire through the bracket.
- b) Punch a 30mm diameter mounting hole at the top center of the swing barrier turnstile.
- c) Insert the bracket into the hole and fix it with a nut.
- d) Adjust the angle of the device.

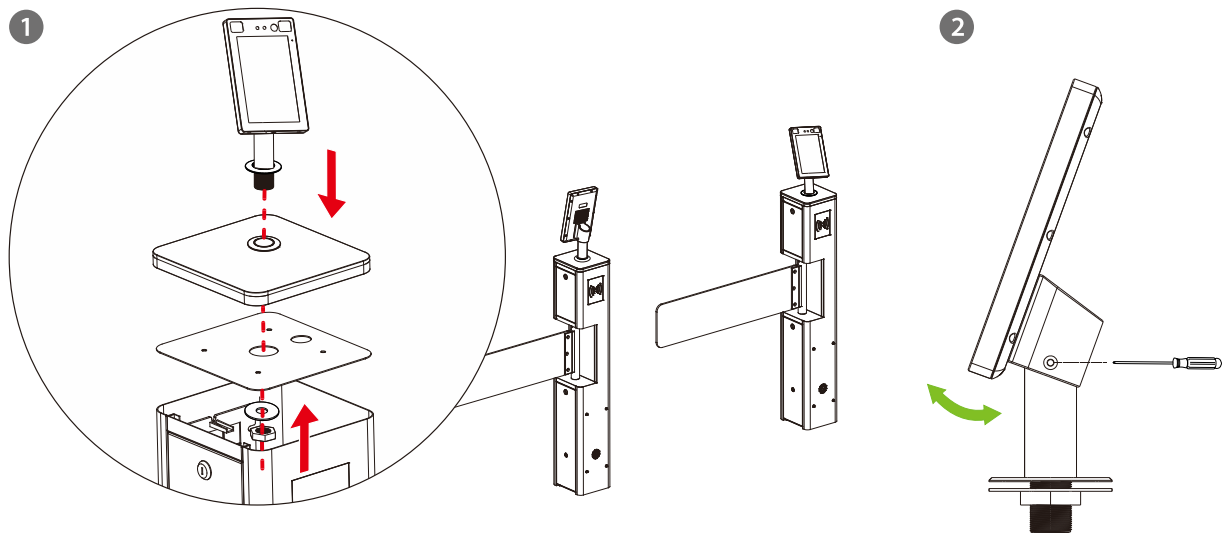

3 Control System Introduction

3.1 Wiring Diagram

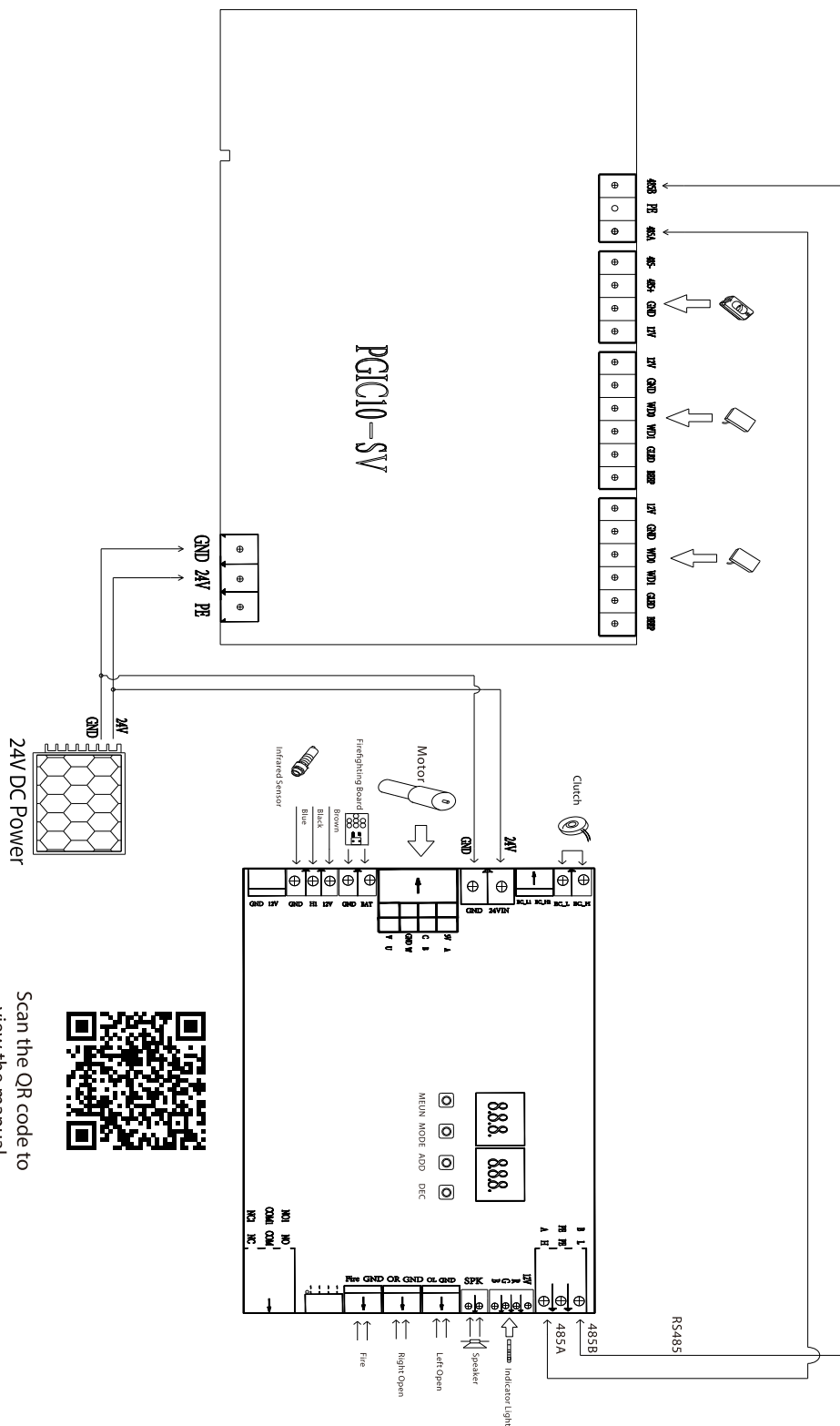

Scan the QR code to view the manual



3.2 Access Control Board★

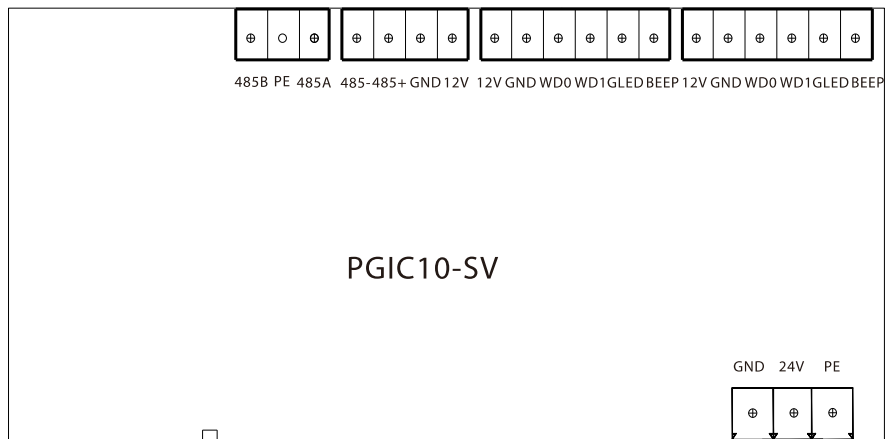

Terminal	Description
	RS485
	485 Reader
	Wiegand Reader
	Wiegand Reader
	24V Power Supply

3.3 Turnstile Control Board

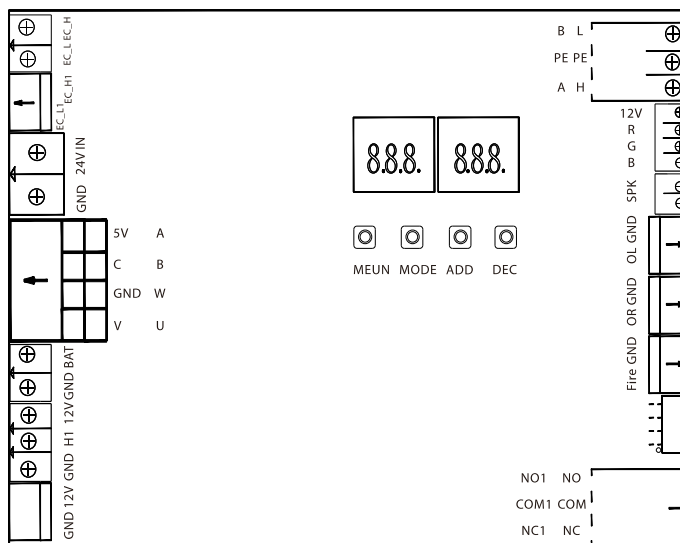



There are 4 keys on the master motor driving controller, "MENU", "MODE", "ADD" and "DEC".



MENU: Used to access the Settings menu and confirm modified values.

MODE: Returns to the previous menu and cancels the current operation.

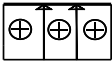
ADD: Navigate to the upper menu item and increase the value.

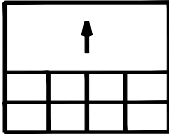
DEC: Navigate to the lower menu item and decrease the value.

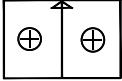
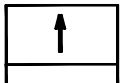
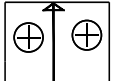
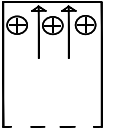
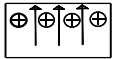
Terminal	Description
 <p>GND 12V</p>	12V Power Supply Input
 <p>GND H1 12V</p>	Infrared Sensor
 <p>GND BAT</p>	Firefighting Board
 <p>V GND C 5V U W B A</p>	Motor

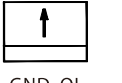
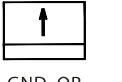
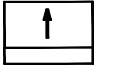
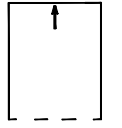
 <p>GND 24VIN</p>	<p>24V Power Supply Input</p>
 <p>EC_L1 EC_H1</p>	<p>Clutch</p>
 <p>EC_L EC_H</p>	<p>Clutch</p>
 <p>L PE H B PE A</p>	<p>RS485</p>
 <p>12VR G B</p>	<p>Indicator Light</p>
 <p>SPK</p>	<p>Speaker</p>
 <p>GND OL</p>	<p>Left Open (Out)</p>
 <p>GND OR</p>	<p>Right Open (In)</p>
 <p>GND Fire</p>	<p>Fire</p>
 <p>NO COM NC NO1 COM1 NC1</p>	<p>Ethernet</p>

3.4 Menu of Speed Gate

Display Mode (01EXXX)

- (01E000) Displays current position of the gate
- (01E001) Infrared input signal
- (01E002) Controls input signal
- (01E003) Test mode (the digital LED displays "---" in the test mode)
- (01E004) Version number (Default)

Opening Mode Setting (02EXXX)

- (02E001) Two-way controlled, both need verification (Default).

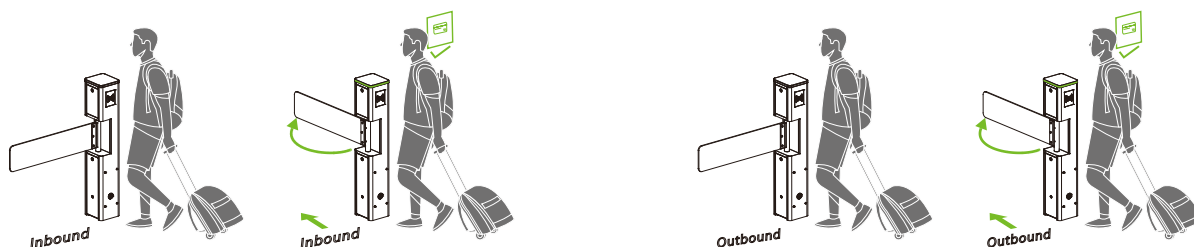

- (02E002) In need verification, out prohibited.

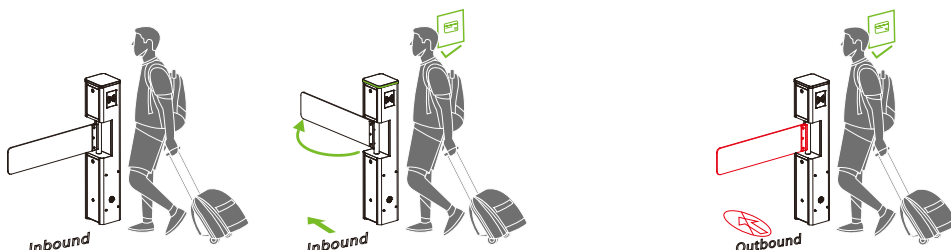

- (02E003) In prohibited, out need verification.

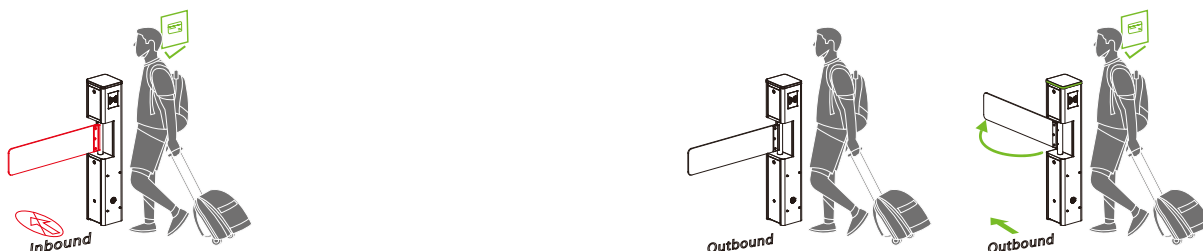

- (02E004) Two-way prohibited.

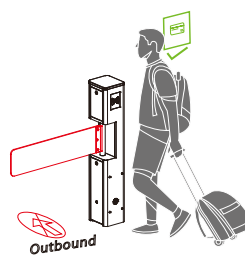
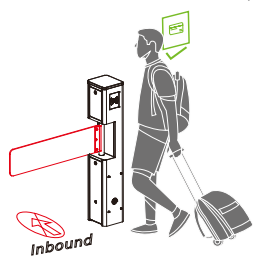

- (02E005) Two-way normally open.

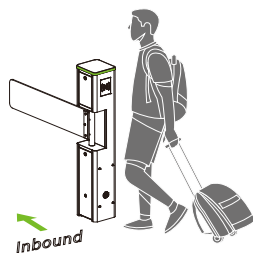

Gate Opening Speed (03EXXX)

To adjust the gate opening speed, you can set a larger number for a faster opening. The Gate Opening Speed can be configured between 5 and 32, with a default value of 10.

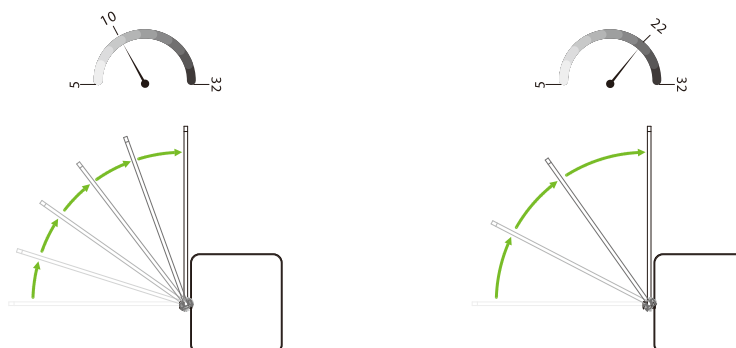

Gate Opening Deceleration Distance (04EXXX)

A larger number increases the deceleration time, enhancing the stability of the swing arm operation. The Gate Opening Deceleration Distance can be set between 0 and 50, with a default value of 10.



Gate Opening Compensation Speed (05EXXX)

This setting is used when the swing arm cannot fully open or shakes during operation. A larger number of results in faster compensation speed. The Gate Opening Compensation Speed can be set between 0 and 50, with a default value of 12.

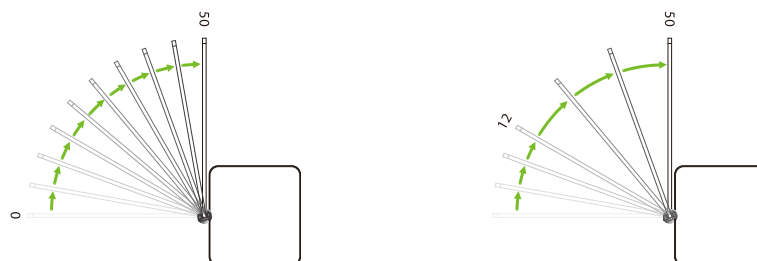

Gate Closing Speed (06EXXX)

Set the gate closing speed to close the gate. The larger the number is set, the faster the speed. The Gate Closing Speed value can be set between 5 to 32 and the default value is 10.

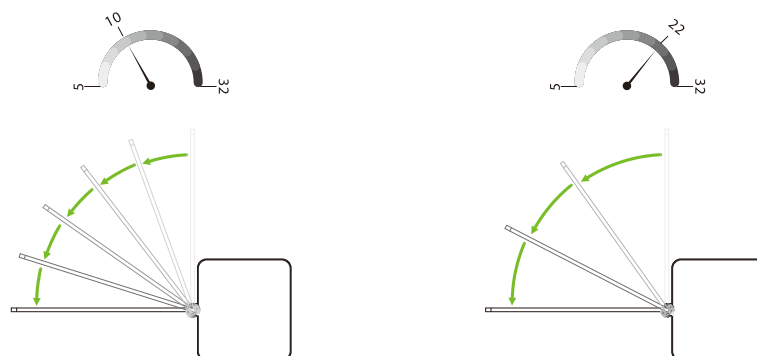

Gate Closing Deceleration Distance (07EXXX)

The larger the number, the longer the deceleration time and the more stable the swing arm operation. The Gate Closing Deceleration Distance value can be set between 0 to 50 and the default value is 10.

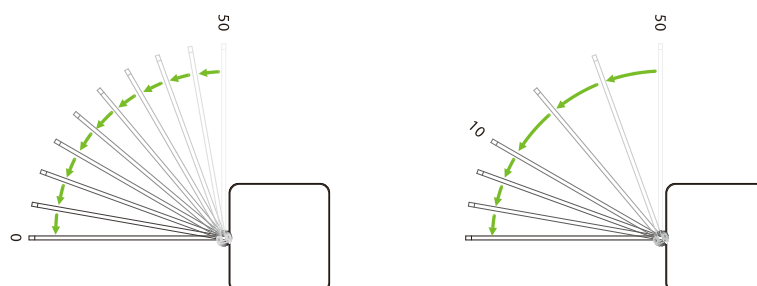

Gate Closing Compensation Speed (08EXXX)

It can be set when the swing arm cannot close to the zero position or shakes. The larger the number is set, the faster of the compensation speed. The Gate Closing Compensation Speed value can be set between 0 to 50 and the default value is 12.

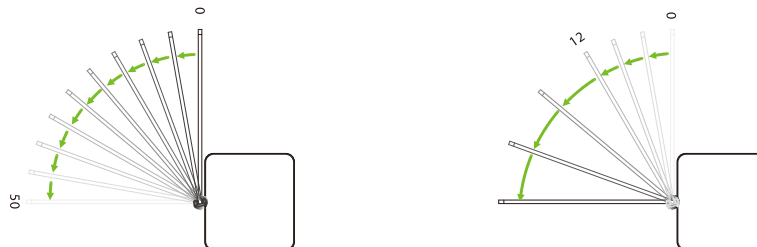

Master/Slave Setting (09EXXX)

Setting up the gate as a master or a slave, the SBT2000S (2023) is an independent system, there is no multi-lane management system, so there is no master-slave relationship.

- (09E000) Master (Default)
- (09E001) Slave

RS485 Address (10EXXX)

It can be set between 0 to 254 and the default value is 0.

Open Duration Time (11EXXX)

The valid time period after a successful verification can be configured. Once the set time is reached, the gate will automatically close. The longer the number set, the longer the valid time. The valid value ranges from 2 to 60 seconds, with a default value of 5 seconds.

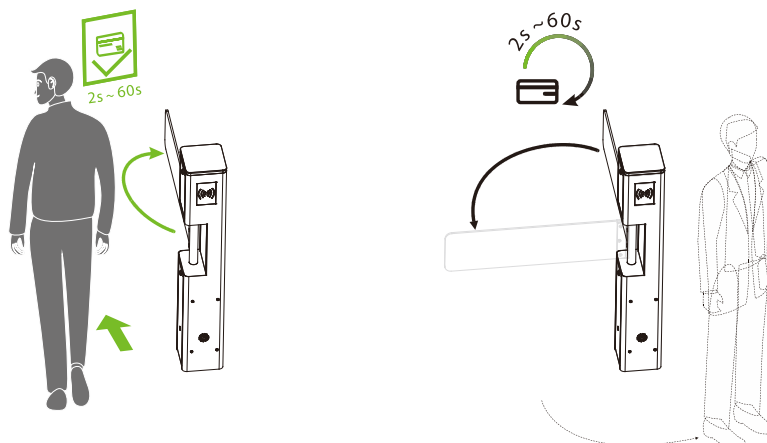

Gate Closing Delay Time (12EXXX)

Set the delay time of gate closing after passing. The valid value for gate closing delay time can be set between 2 to 60s and the default value is 2s.

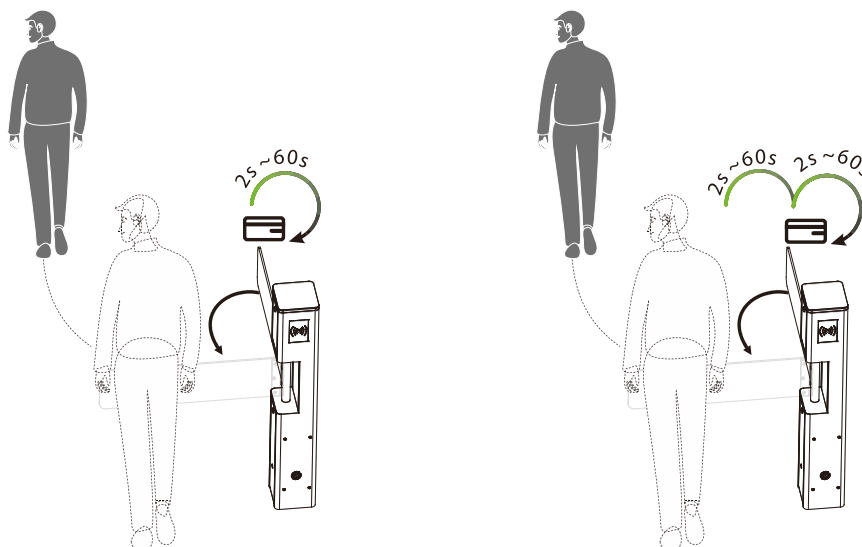

Adjustment Limit (13EXXX)

- (13E001) Zero position (Default)
- (13E002) Right position
- (13E003) Left position
- (13E004) Slave position

1. Adjust the position only when SBT2000S (2023) series is installed properly.
2. When setting the zero position, you can manually push the swing arm for fine-tuning. If the barrier exceeds a certain angle, it will be invalid.

Volume Setting (14EXXX)

Volume Setting is used for adjusting the volume of the device. The larger the number is set, the louder the volume. The valid value for Volume Setting can be set between 1 to 100 and the default value is 70.

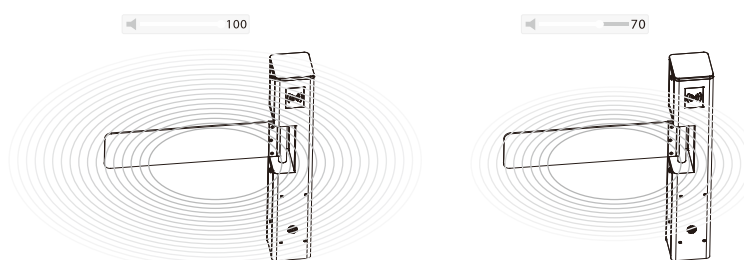

Close Alarm Tone (15EXXX)

When the alarm tone is turned off, the Turnstile will not emit an alarm tone when encountering an alarm situation. The following figure shows an example of the swipe verification:

- (15E000) Close

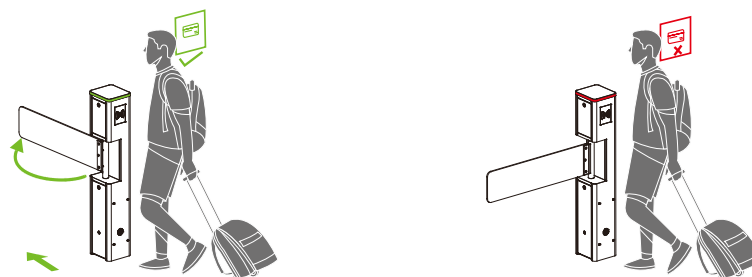

- (15E001) Open (Default)

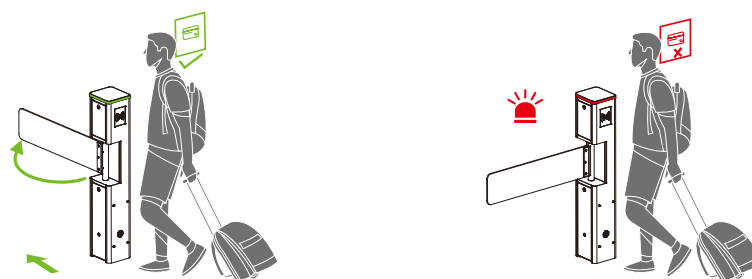

Stay Duration Time (16EXXX)

Set the duration of stay in the lane after successful verification. The valid value for Stay Duration Time can be set between 5 to 30 seconds and the default value is 10s.

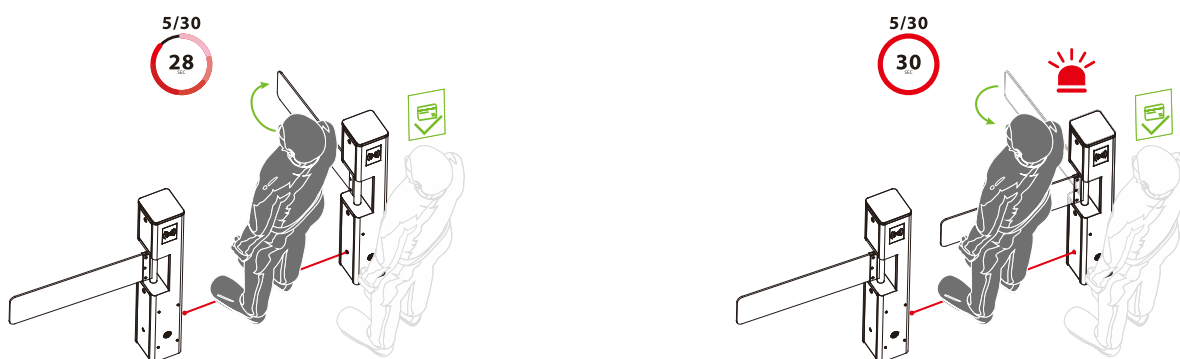

Force Adjustment (17EXXX)

The larger the number, the greater the efficiency of the gate opening and closing force. The valid value for Force Adjustment can be set between 10 to 100 and the default value is 50.

Fire Opening Direction (18EXXX)

According to the external fire device, select the corresponding type of trigger mode.

- (18E000) Entry direction (Default)
- (18E001) Exit direction



Clutch Locking Stroke (19EXXX)

Set the angle at which the clutch starts. The larger the number, the bigger the angle. The valid value for Clutch Locking Stroke can be set between 0 to 99, and the default value is 10. When setting it to 0 do not lock it, adapting it to movements without a clutch.

Clutch Locking Mode (20EXXX)

When the gate is unlocked in an unauthorized way, the clutch gets locked automatically. Swipe a valid card to dismiss the alarm.

- (20E000) Delayed unlock (Default)
- (20E001) Authentication to unlock.



Restore Factory Setting (21EXXX)

- (24E001) Restore factory settings.

Anti-pinch Action Setting (22EXXX)

- (22E000) Stop
- (22E001) Open (Default)
- (22E002) Close the function

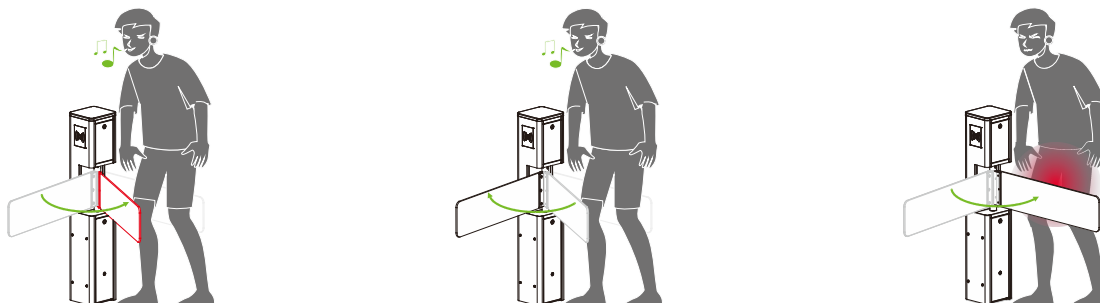

Voice Switching (23EXXX)

Sets whether the device announces a voice or an alarm tone.

- (23E000) Voice playback

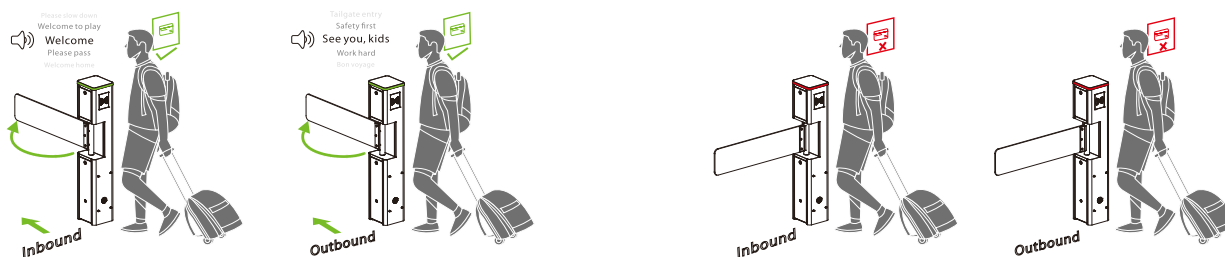

- (23E001) Alarm tone (Default)



Motor Installation Direction (24EXXX)

- (24E000) Inverted (Default)
- (24E001) Upright

Right Synchronous Adjustment (25EXXX)

Set the gate opening compensation speed in the direction the master inbound, the default value is 100, the larger the value, the faster the speed.

Left Synchronous Adjustment (26EXXX)

Set the gate opening compensation speed in the direction the master outbound, the default value is 100, the larger the value, the faster the speed.

Zero Position Strength Adjustment (27EXXX)

Set the strength of the swing arm to return to the zero position, the larger the value, the stronger the strength, the valid value of the zero position strength adjustment is 1 to 10, and the default value is 2.

3.5 Error Code for Turnstile

Error Code	Cause
ER0002	Power-on Self-test failure, Hall Limit Detection Error
ER0004	Run Timeout
ER0008	Clutch Locked
ER016	The code disk detection failed.
ER032	Electric Motor Shaft Lock Protection failure

4 Troubleshooting

Failure Description	Solution
The mode indicator light does not respond or the indication is incorrect.	Check that the control panel mode indicator wiring is correct or that the contact is poor.
When the gate is self-tested, the swing arm is not in the normal closing position!	During the self-test, if obstacles are detected, please remove them. Then, restart the self-test after powering on the system.
The gate doesn't open to limit.	If the motor resistance is too high, adjust the minimum compensation speed accordingly.
There's no sound.	Check speakers for loose wiring or turn off sound.
The swing arm is not centered.	To adjust the zero position, navigate to the "Limit Adjustment" menu.
After successful verification, open the gate in the direction of the authorized person.	Access control controller in and out of the open gate signal line is reversed, can be adjusted.
Verification was successful, the gate did not open.	<ol style="list-style-type: none"> 1. Check if it is not exited in the menu setting interface. 2. Check if the gate opening signal line is properly connected to the gate controller. 3. Enter the menu to confirm whether the current access mode is set to prohibit access.

5 Maintenance

5.1 Chassis Maintenance

The chassis is made of SPCC. If it has been used for a long time, the surface may develop rust stains. It is recommended to clean the surface regularly with a clean cloth and apply anti-rust oil, making sure not to cover the infrared sensor.

5.2 Movement Maintenance

Before performing maintenance, ensure the power is turned off. Open the door, wipe away surface dust, and apply lubricant for smooth movement.







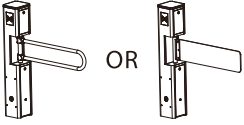

5.3 Power Supply Maintenance

- Switch off the power supply before conducting maintenance.
- Check the power plug connection ; if loose, securely fix it.
- Do not change any connection position randomly.
- Periodically check the insulation of the external power supply.
- Conduct regular checks for any potential leakage.
- Check if the technical parameters of the interface are normal.
- Check the service life of the electronic components and replace them accordingly.

Caution: All maintenance procedures for the swing barrier mentioned above should be carried out by a professional technician, especially when handling movement and electric control components. To guarantee operational safety, it is crucial to switch off the power supply when the barrier is not in use.

6 Packing List

The package consists of the following items:

	<p>SBT2000S (2023)</p>	<p>1</p>
	<p>Power Cable</p>	<p>1</p>
	<p>Card</p>	<p>1</p>
	<p>Keys</p>	<p>2</p>
	<p>Expansion Screw M12*100</p>	<p>4</p>
	<p>Washer</p>	<p>4</p>
	<p>Expansion Screw Washers</p>	<p>4</p>
	<p>Stainless Steel Maintenance Wipes</p>	<p>1</p>
	<p>Hex Wrench</p>	<p>1</p>

